

Zigbee 3.0 Wall Mounted Touch Panel

Model No.: TS4(WZS)

4 Scene button/Zigbee 3.0/Glass touch panel/AC input

Features

- 4 button touch scene panel remote with scene recall function.
- Built-in Tuya Zigbee 3.0 remote module, supports scenario linkage and one-click execution.
- Set scene function through Tuya APP.
- Ultra sensitive high strength glass touch panel.
- Each button with blue LED indicator.
- Customizable button words.
- Provide a variety of Chinese/English scene button pasters, which can flexibly define the functions of each button.



CE RoHS LVD RED

Technical Parameters

Input and Output		Safety and EMC		Environment	
Input voltage	100-240VAC	EMC standard (EMC)	ETSI EN 301 489-1 V2.2.3	Operation temperature	Ta: -30°C ~ +55°C
Input current	Max 0.1A		ETSI EN 301 489-17 V3.2.4	Case temperature (Max.)	Ta: +65°C
Output signal	Zigbee 3.0	Safety standard(LVD)	EN 62368-1:2020+A11:2020	Package	
Dimming data		Radio Equipment(RED)	ETSI EN 300 328 V2.2.2	Size	L112x W112 x H50mm
Input signal	Touch key	Certification	CE,EMC,LVD,RED	Gross weight	0.223kg
Remote distance	30m(Barrier-free space)	Warranty	5 years		

Mechanical Structures and Installations

AC input N ————— AC input L

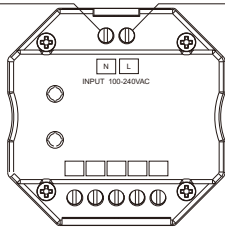

Installation diagram:

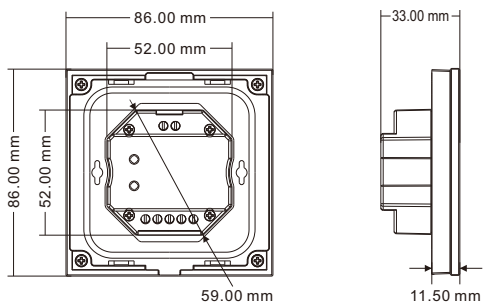
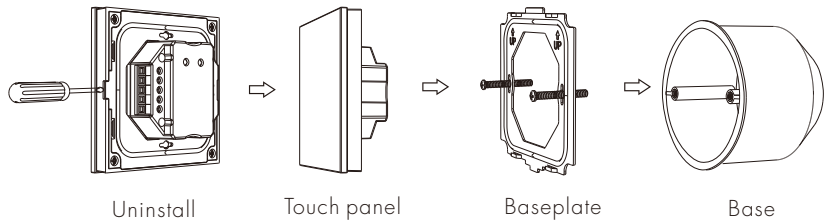

Typical base as below:

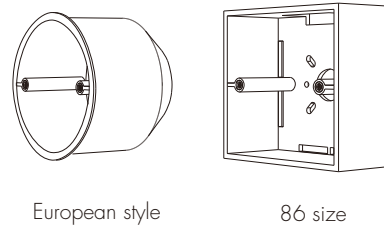

Key function

Short press the scene button to recall the corresponding scene, the blue indicator lights up. Before use the scene panel, please edit the scene setting through Tuya APP firstly.

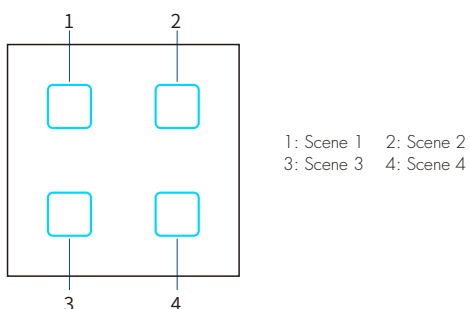

App Operating Instructions

1. Network pairing

- Download the Tuya APP and register an account, search and add the Tuya Zigbee gateway device.
- Press and hold the "Scene 1" and "Scene 4" button until the 4 LED indicator light flashes.
Under the gateway, you can find WZS-Scene Panel device in Tuya APP.
After successful network pairing, the 4 LED indicator light will be on for 2 seconds and then off.
- Under the gateway, search and add one or more ZBS-DIM, ZBS-CCT, ZBS-RGB, ZBS-RGBW, ZBS-RGB+CCT light devices.
- Scene panel unpairing: Delete the WZS-Scene Panel device from the Tuya APP.

2. Remote association and scene settings

There are 8 scenes in the Tuya APP, which can be set to lighting scenes or linkage scenes.

Lighting scene is used for the overall control of multiple lamps, like the light adjustment of the entire room.

Linkage scene is used for linkage control of different equipment, such as lamps and curtains on and off together.

Example 1, set scene 1 for synchronous light control of the whole room:

- (1) Select scene 1 and open the lighting scene settings.
- (2) You can change the scene name, add one or more devices, adjust brightness and color, then save it.
- (3) After successful setting, you can use the remote to control these lamps directly.

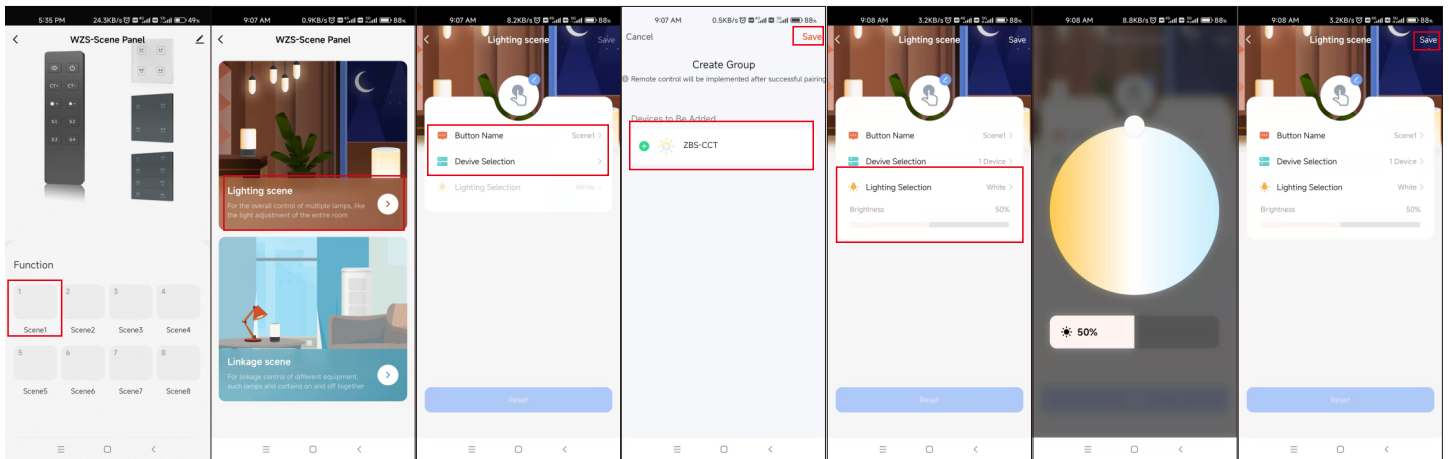

Example 2, set scene 2 to set up a scenario where different lamps or curtains are controlled together with different color or on/off state.

- (1) Select Scene 2 and open the linkage scene settings.
- (2) You can change the scene name, add "one-click execution" tasks, select the devices that need to be linked, save the required functions, such as ON/OFF, mode, brightness and color temperature.
- (3) After successful setup, you can use the remote to directly control all linked devices to the desired scene.

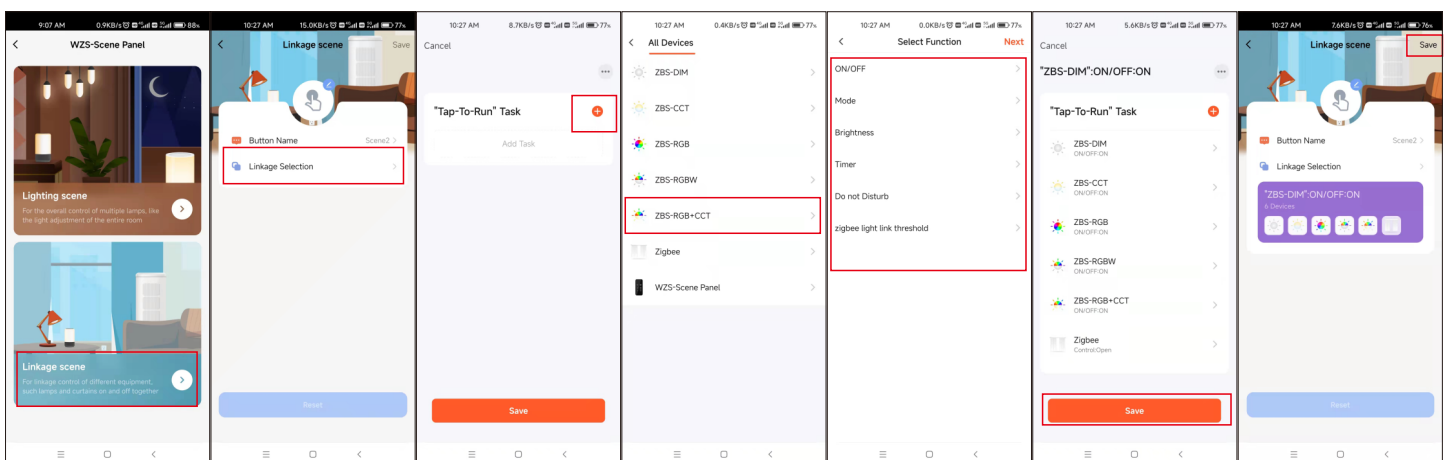

Note:

- The scene 1-4 in Tuya APP is correspond to the scene 1-4 button on the scene panel.
- You can select one scene button to set ALL OFF linkage scene function to turn off all lights.
- To delete the scene function, you can select "Reset" in the scene settings.