

Product Specification

Title	TRIAC & Phase Cut Dimmable LED Driver
Model	BQ-050TNPC (Flicker Free)
Specification	Input: 220~240Vac 50/60Hz Output: 50-72V/600mA 24-42V/1000mA
Power Range	24-42W
Author	R&D
Document NO.	RDPS-2106
Date	2021-01-03
Revision	2.0

1. Product Describes

1.1 This engineering report describes the design for a **TRIAC & Phase Cut dimmable Constant Current led driver** for LED applications.

1.2 Prototype Photo

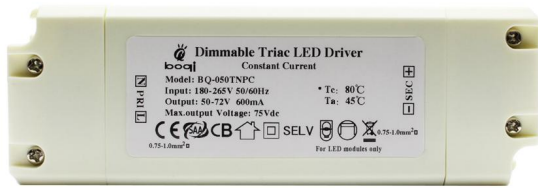

1.3 Physical size

L (mm)	W (mm)	H (mm)
140	47	28
±1	±1	±1

1.4 Working principle

BQ-050TNPC TRIAC Dimmable LED Driver is with the Constant Current feature, the working condition is as the picture under.

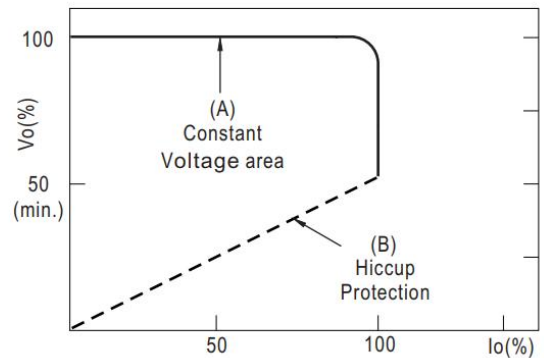

Typical output current normalized by rated current (%)

1.5 Circuit Drawing

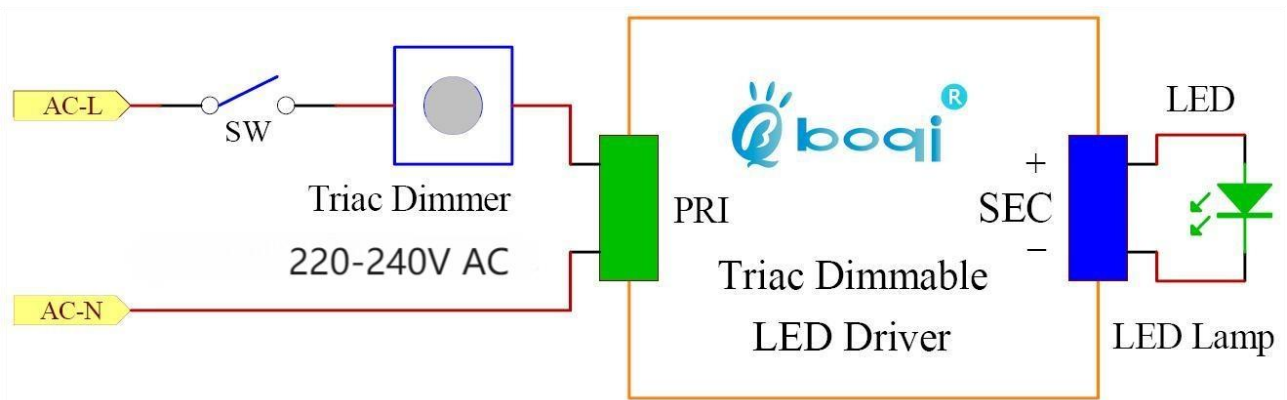

2. Electric Idiosyncrasy



2.1 Specs.

Model	BQ-050TNPC		
Output	DC Voltage	50-72V	24-42V
	Output Current	600mA	1000mA
	Output Power	24-42W	
	Flicker Index	Modulation depth ≤1% Complies with the flicker-free standard (IEEE Std 1789-2015)	
	Current Tolerance	±5%	±5%
	Temperature Drift	±10%	
	Start-up Time	<1.5S@230Vac	
Input	Input Voltage	220-240VAC	
	Frequency Range	47-63Hz	
	Power Factor(Typ.)@ full load	0.97@115VAC 0.95@230VAC	
	THD(Typ.)@ full load	<20%@230Vac (DC42V full load)	
	Efficiency(Typ.)	88%@ full load	88%@ full load
	AC Current(Max.)	0.3A	
	Leakage current	<0.5mA	
	Standby Power Consumption	≤0.5W (when DALI OFF signal is effective)	
Protection	Short Circuit	Hiccup mode (auto-recovery)	
	Over temperature	100°C±10°C shut down o/p voltage, automatically recover after cooling.	
Environment	Working TEMP.	-20°C - +45°C	
	Working Humidity	20~90%RH, non-condensing	
	Storage TEMP.Humidity	-30~+80°C, 10~90%RH	
	Atmospheric Pressure	86kPa~106kPa	
Safety& EMC	Certifications	TUV-CE, CB, SAA, RoHS	
	Safety standards	EN61347	
	Withstand voltage	I/P-O/P: 3.75KVac 5mA 60S	
	Insulation Resistance	I/P-O/P:100MΩ/500VDC/25°C/70%RH	
	EMC EMISSION	EN55015; EN61000-3-2; EN61000-3-3;	
	EMC IMMUNITY	EN61547	
Others	Dimming Function	Compatible with Leading and Trailing Edge Dimmer	
	Dimension	140*47*28 mm (L*W*H)	

2.2 Characteristic Curve

2.2.1 Power Factor Characteristic Curve

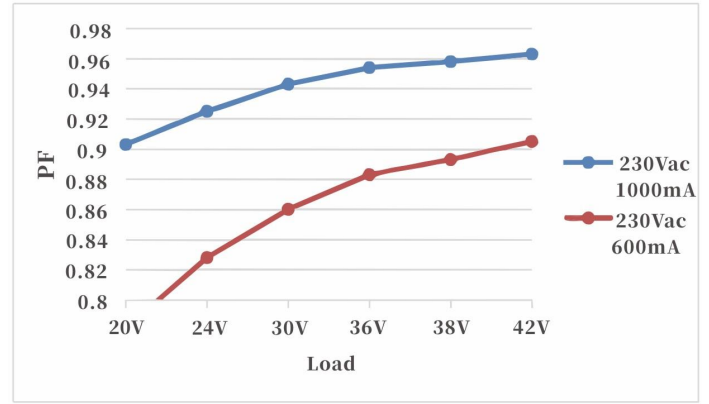
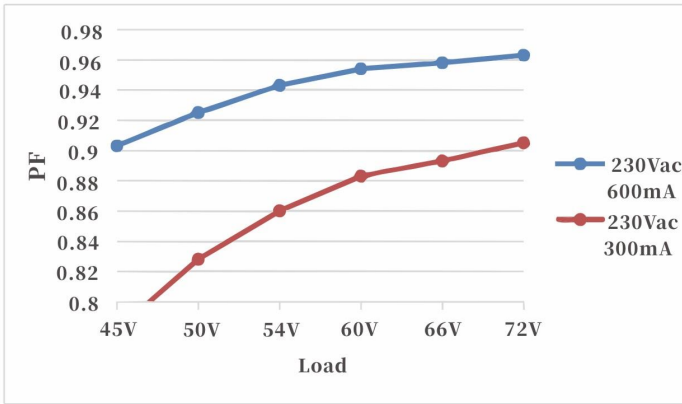

2.2.2 Power Efficiency Characteristic Curve

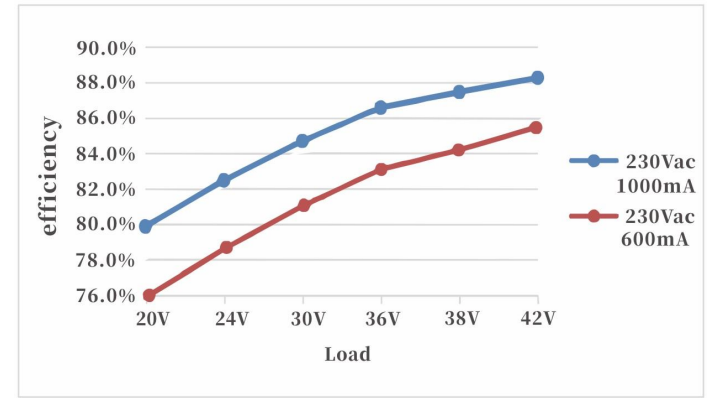
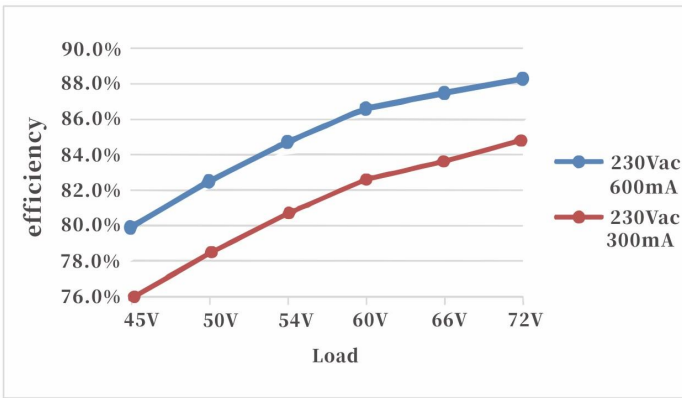

2.2.3 Lifetime Characteristic Curve

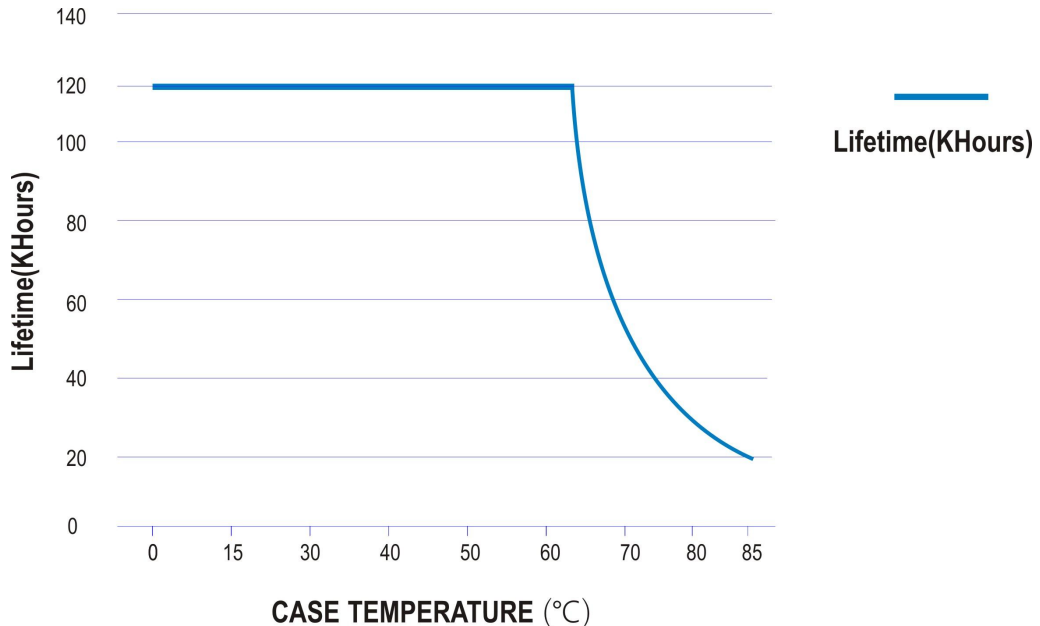

2.2.4 Dimming Curve

Model: BQ-050TNPC

Input: 220 ~ 240 VAC

Output: DC50-72V 600mA

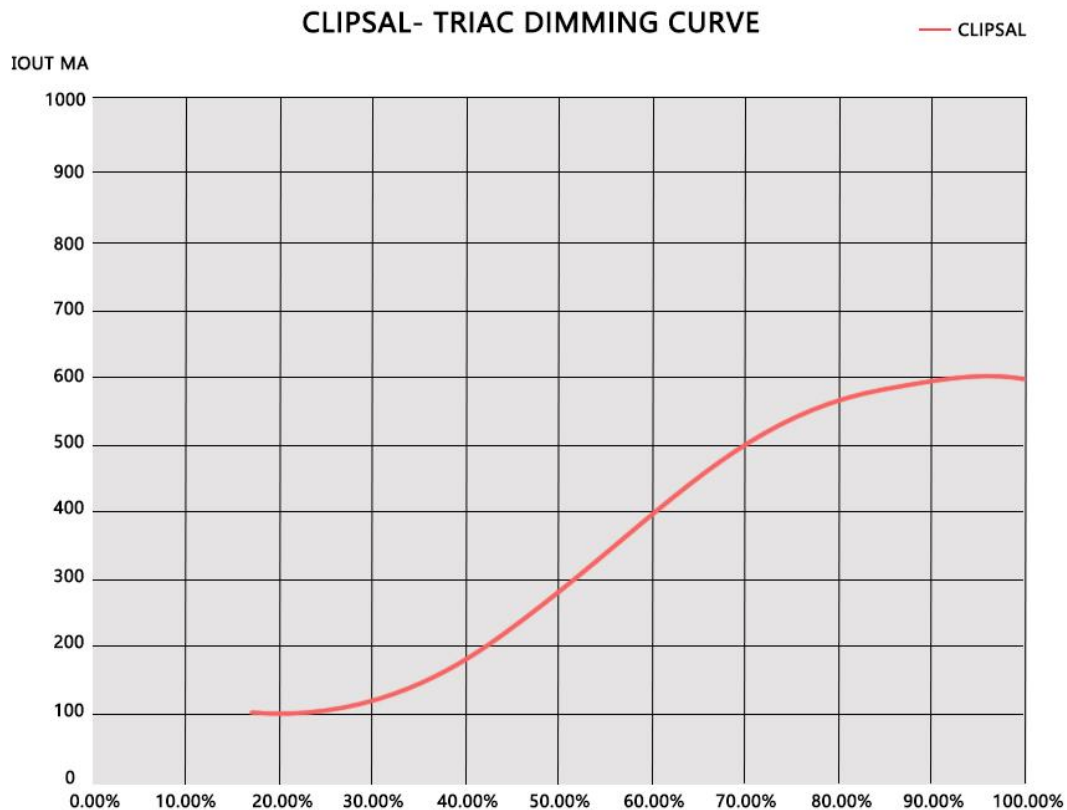

Verified by the boqi team, this driver is compatible with these dimmers:

·CLIPSAL: 32E450UDM

·DIGINET: MEDM

Model: BQ-050TNPC

Input: 220 ~ 240 VAC

Output: DC24-42V 1000mA

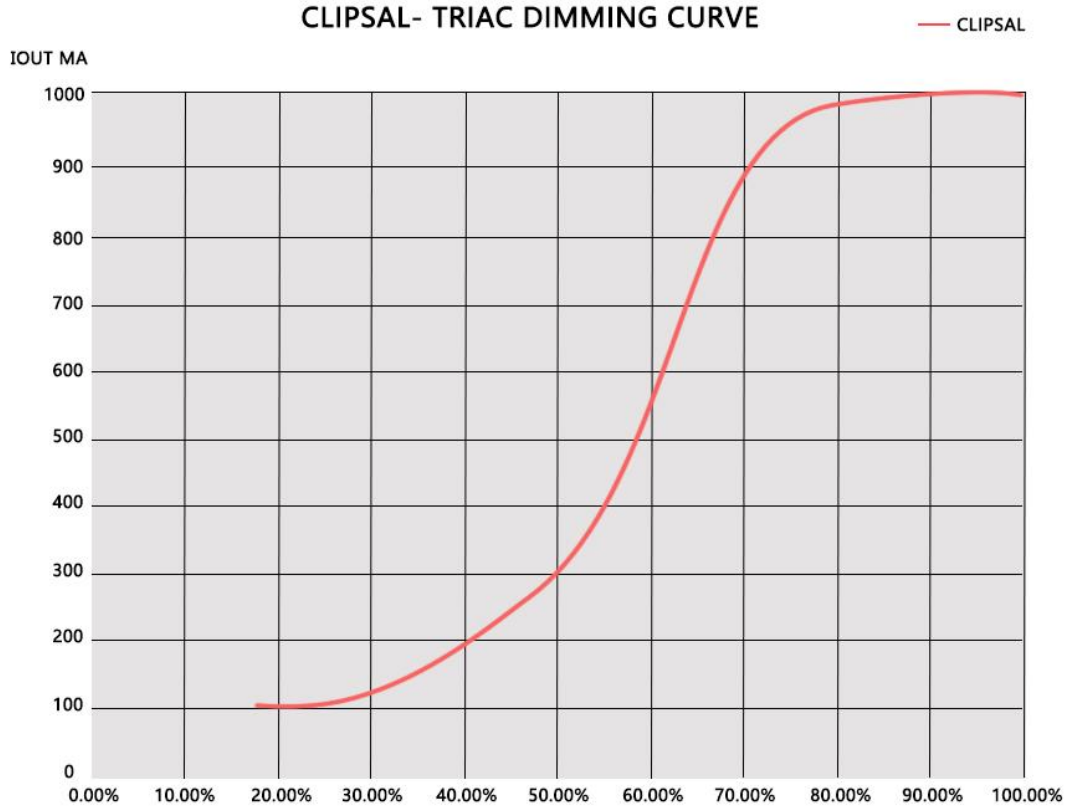

Verified by the boqi team, this driver is compatible with these dimmers:

- CLIPSAL: 32E450UDM
- DIGINET: MEDM

3. Real Photo

