

Product Specification

Title	TRIAC & Phase Cut Dimmable LED Driver
Model	BQ-010TNPC (Flicker Free)
Specification	Input: 220~240Vac 50/60Hz Output: 15-30V/300mA
Power Range	5-9W
Author	R&D
Document NO.	RDPS-2101
Date	2021-01-03
Revision	2.0

1. Product Describes

1.1 This engineering report describes the design for a **TRIAC & Phase Cut dimmable Constant Current led driver** for LED applications.

1.2 Prototype Photo

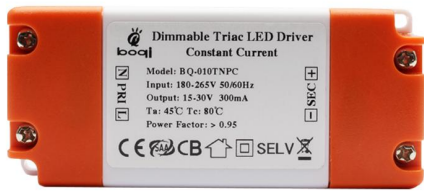

1.3 Physical size

L (mm)	W (mm)	H (mm)
88	38	21
±1	±1	±1

1.4 Working principle

BQ-010TNPC TRIAC Dimmable LED Driver is with the Constant Current feature, the working condition is as the picture under.

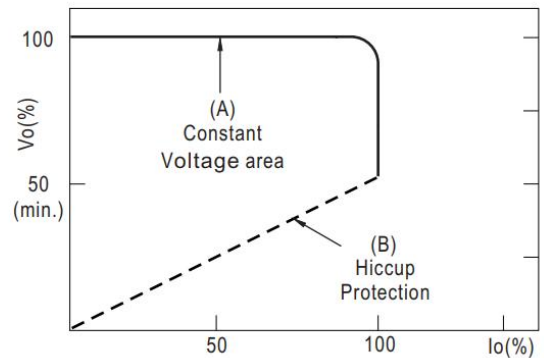

Typical output current normalized by rated current (%)

1.5 Circuit Drawing

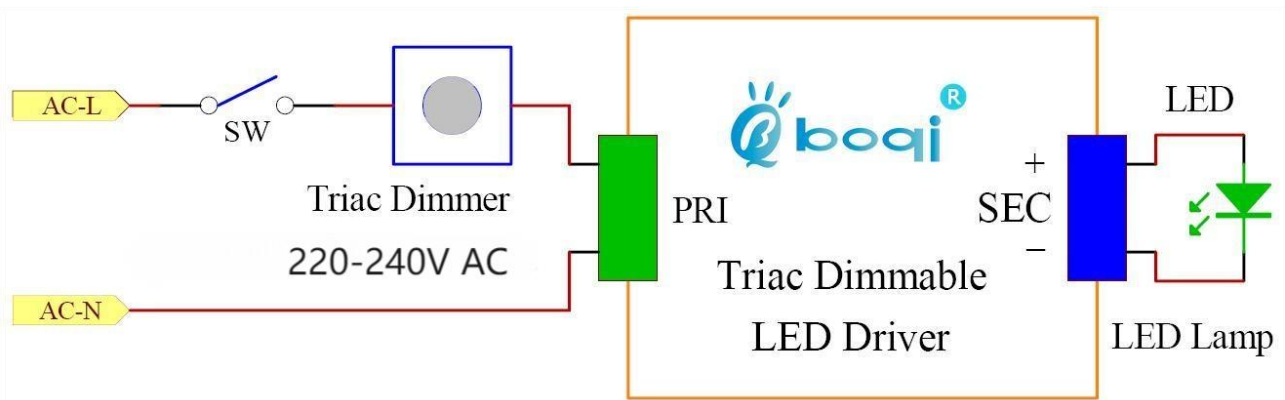

2. Electric Idiosyncrasy



2.1 Specs.

Model	BQ-010TNPC	
Output	DC Voltage	15-30V
	Output Current	300mA
	Output Power	5-9W
	Flicker Index	Modulation depth ≤1% Complies with the flicker-free standard (IEEE Std 1789-2015)
	Current Tolerance	±5%
	Temperature Drift	±10%
	Start-up Time	<1.5S@230Vac
Input	Input Voltage	220-240VAC
	Frequency Range	47-63Hz
	Power Factor(Typ.)@ full load	0.92@115VAC 0.90@230VAC
	THD(Typ.)@ full load	<20%@230Vac
	Efficiency(Typ.)	85%@ full load
	AC Current(Max.)	0.12A
	Leakage current	<0.5mA
Protection	Short Circuit	Hiccup mode (auto-recovery)
	Over temperature	100°C±10°C shut down o/p voltage, automatically recover after cooling.
Environment	Working TEMP.	-20°C - +45°C
	Working Humidity	20~90%RH, non-condensing
	Storage TEMP.Humidity	-30~+80°C, 10~90%RH
	Atmospheric Pressure	86kPa~106kPa
Safety& EMC	Certifications	TUV-CE, CB, SAA, RoHS
	Safety standards	EN61347
	Withstand voltage	I/P-O/P: 3.75KVac 5mA 60S
	Insulation Resistance	I/P-O/P:100MΩ/500VDC/25°C/70%RH
	EMC EMISSION	EN55015; EN61000-3-2; EN61000-3-3;
	EMC IMMUNITY	EN61547
Others	Dimming Function	Compatible with Trailing Edge Dimmer
	Dimension	88*38*21 mm (L*W*H)

2.2 Characteristic Curve

2.2.1 Power Factor Characteristic Curve

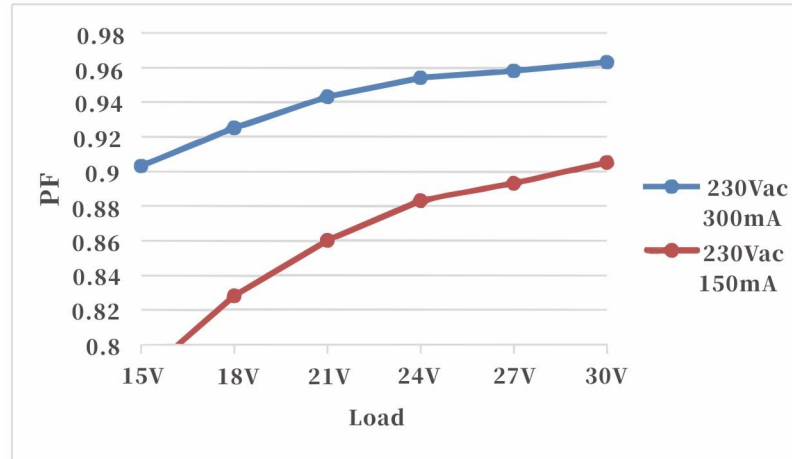

2.2.2 Power Efficiency Characteristic Curve

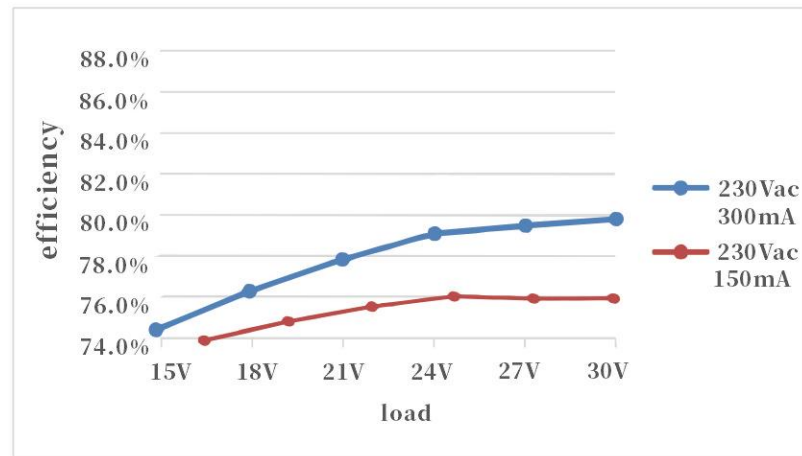

2.2.3 Lifetime Characteristic Curve

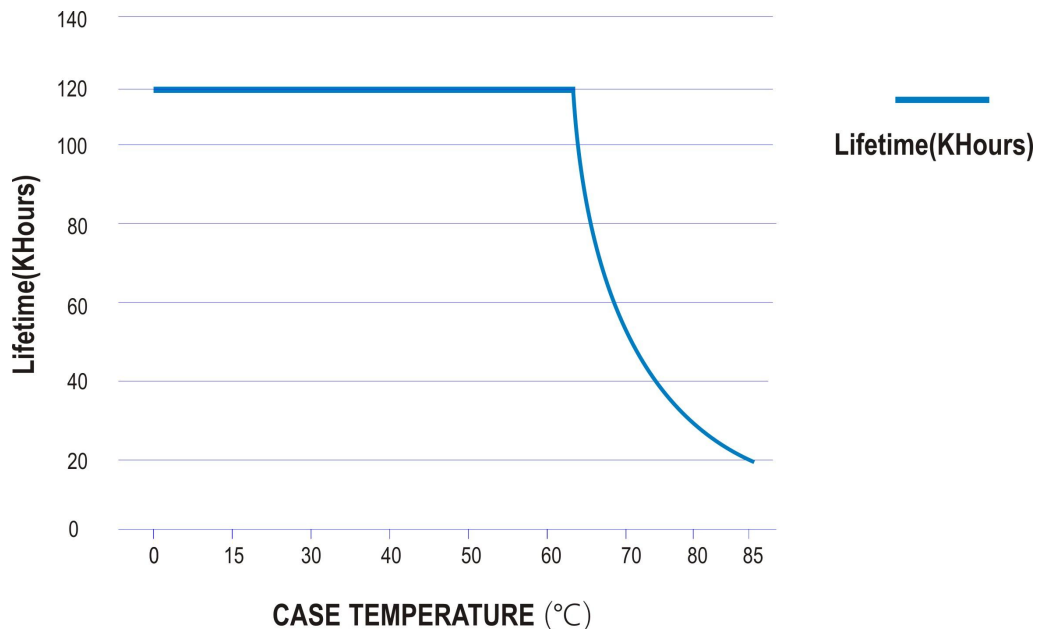

2.2.4 Dimming Curve

Model: BQ-010TNPC

Input: 220 ~ 240 VAC

Output: DC15-30V 300mA

CLIPSAL- TRIAC DIMMING CURVE

— CLIPSAL

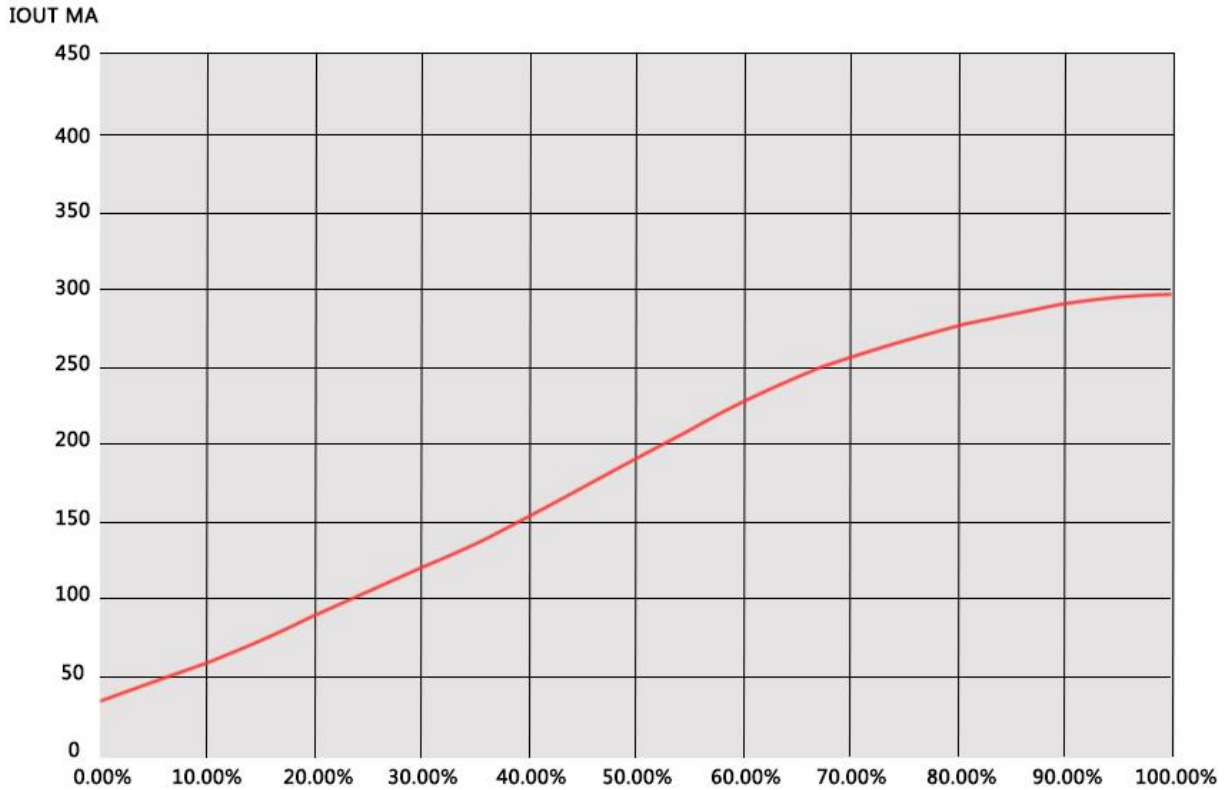

Verified by the boqi team, this driver is compatible with these dimmers:

·CLIPSAL: 32E450UDM

·DIGINET: MEDM

3. Real Photo

