

Wall Mounted Touch Panel

Model No.: T2-L

2 channel 0/1-10V signal output / Touch glass panel / CCT Dimming / AC input / Wireless remote control

Features

- Touch panel RF 0/1-10V dimmer, output 2 channel 0/1-10V signal for CCT dimming.
- The two channel output can be set as warm white and cool white respectively, or one for brightness adjust and the other for color temperature adjust.
- 0-10V or 1-10V output selectable by DIP switch.
- 256 levels 0-100% dimming smoothly without any flash.
- Compatibility with RF 2.4G single zone or multiple zone remote control.
- Ultra sensitive high strength glass touch panel with touch color slide.
- Smooth and accurate color adjustment by touching the color slide.
- Touch keys with LED indicator.
- White & Black glass panel available.



CE RoHS

Technical Parameters

Input and Output		Dimming data		Safety and EMC	
Input voltage	AC100-240V	Input signal	RF 2.4GHz	EMC standard (EMC)	ETSI EN 301 489-1 V2.2.3 ETSI EN 301 489-17 V3.2.4
Output signal	2 x 0/1-10V	RF Control distance	30m(Barrier-free space)	Safety standard	EN 62368-1:2020+A11:2020
Output current	20mA/CH	Dimming level	256 levels	Radio Equipment(RED)	ETSI EN 300 328 V2.2.2
Environment		Dimming range	0-100%	Certification	CE,EMC,RED
Operation temperature	Ta: -30°C ~ +55°C	Package		Warranty	
Case temperature (Max.)	Ta: +65°C	Size	L112 x W112 x H50mm	Warranty	5 years
IP rating	IP20	Gross weight	0.230kg		

Mechanical Structures and Installations

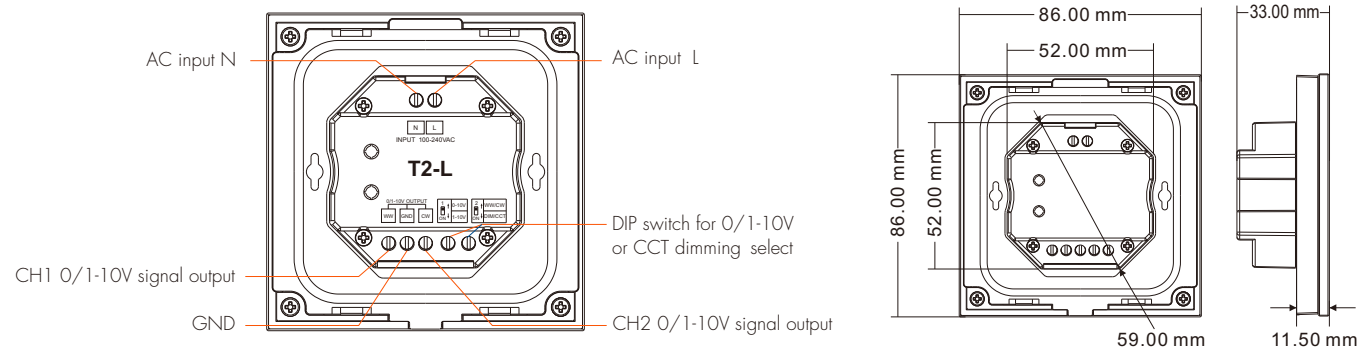

Installation diagram:

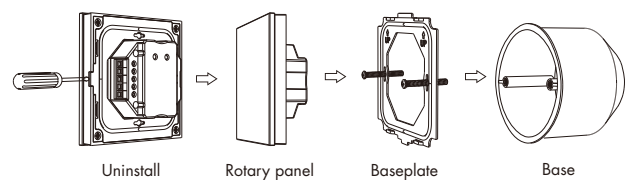

Typical base as below:

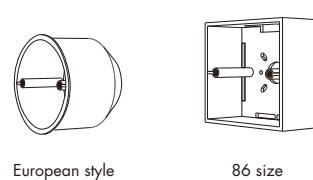

Key function

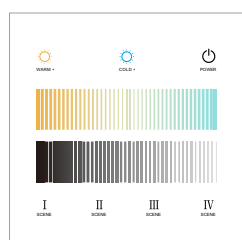

- Turn on/off light.
- Increase color temperature, 10 levels.
- Decrease color temperature, 10 levels.
- Color temperature slide.
- Brightness slide.
- Short press recall the scene, long press 5s save current color into scene 1/2/3/4.

Wiring diagram

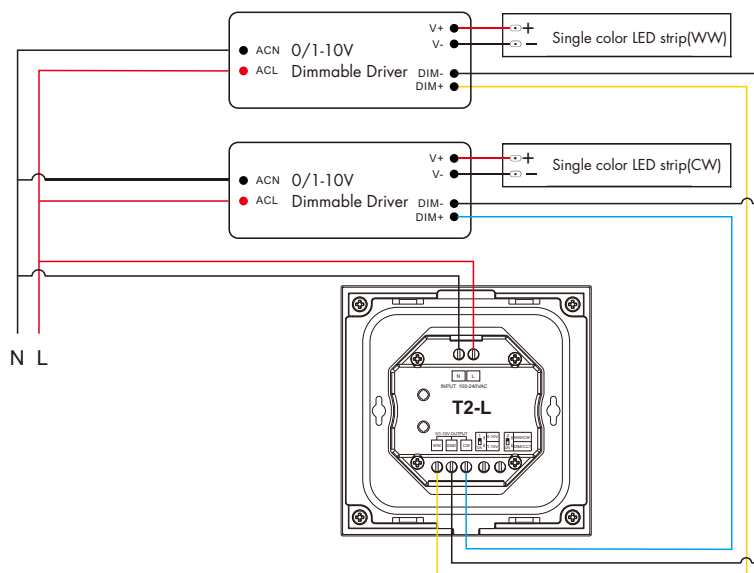

Note:

We recommend the number of LED drivers connected to 0/1-10V dimmer does not exceed 50 pieces, The maximum length of the wires from dimmer to LED driver should be no more than 50 meters.

Match Remote Control (two match ways)

The 0-10V touch panel dimmer can also match with the RF remote (optional).

End user can choose the suitable match/delete ways. Two options are offered for selection:

Use On/Off key

Match:

Turn on light, turn off, immediately press the On/Off key of the panel for 5s, then press on/off key(single zone remote) or zone key(multiple zone remote) of the RF remote within 5s. The LED indicator fast flash 3 times means match is successful.

Delete:

Turn on light, turn off, immediately press the On/Off key of the panel for 10s to delete all match, The LED indicator fast flash 6 times means all matched remotes were deleted.

Use Power Restart

Match:

Switch off the power, then switch on power, repeat again, Immediately short press on/off key (single zone remote) or zone key (multiple zone remote) 3 times on the remote. The light blinks 3 times means match is successful.

Delete:

Switch off the power, then switch on power, repeat again, Immediately short press on/off key (single zone remote) or zone key (multiple zone remote) 5 times on the remote. The light blinks 5 times means all matched remotes were deleted.

0-10V or 1-10V dimming setting

Select 0-10V dimmer or 1-10V dimmer according to dimmable LED driver.

0-10V Dimmer

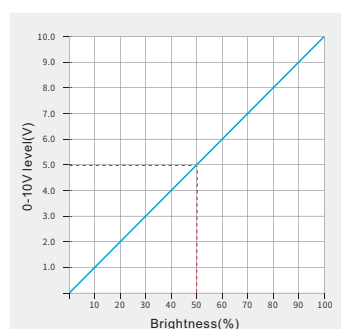

1-10V Dimmer

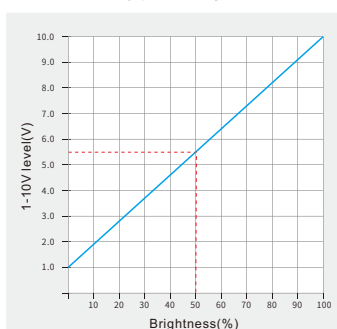

CCT dimming setting

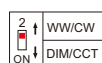

Select the DIP switch 2 OFF, set as CH1 for warm white dimming and CH2 for cool white dimming respectively.

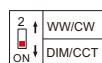

Select the DIP switch 2 ON, set as CH1 for for brightness adjust and CH2 for color temperature adjust.