

AC Triac DMX Dimmer

Model No.: S1-D

2 Channel/RDM/Stand-alone function/Leading edge or trailing edge/Numeric display

Features

- AC phase-cut mosfet dimmer with DMX512 function, two channel output.
- Comply with the DMX512 standard protocols.
- Digital numeric display, set DMX decode start address by buttons.
- RDM function can realize intercommunication between DMX master and decoder.
For example, DMX decoder address can be set by DMX master console.
- 1/2 DMX channel output selectable.
- Reverse-phase dimming or forward-phase dimming selectable.
- Minimum brightness set from 1% to 40%.
- Stand-alone dynamic mode and 2 channel dimmer mode selectable, which be controlled by buttons with built-in programs, instead of DMX signal.
- To dim and switch single color dimmable LED lamps, traditional incandescent and halogen lights.
- Over-heat protection, recover automatically.

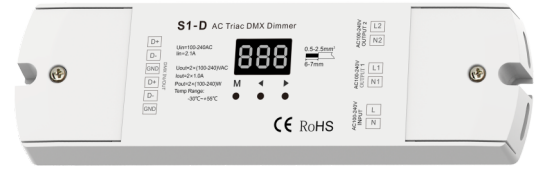

CE RoHS emc LVD

Technical Parameters

Input and Output		Safety and EMC		Environment	
Input voltage	100-240VAC	EMC standard (EMC)	ETSI EN 301 489-1 V2.2.3	Operation temperature	Ta: -30°C ~ +55°C
Output voltage	2 x (100-240)VAC	ETSI EN 301 489-17 V3.2.4		Case temperature (Max.)	Ta: +85°C
Output current	2CH, 1A/CH	Safety standard(LVD)	EN 62368-1:2020+A11:2020	IP rating	IP20
Output power	2 x (100-240)W	Certification	CE,EMC,LVD	Package	
Dimming data		Warranty		Size	L175x W54 x H27mm
Dimming level	256 levels	Warranty	5 years	Gross weight	0.135kg
Dimming range	0-100%				

Mechanical Structures and Installations

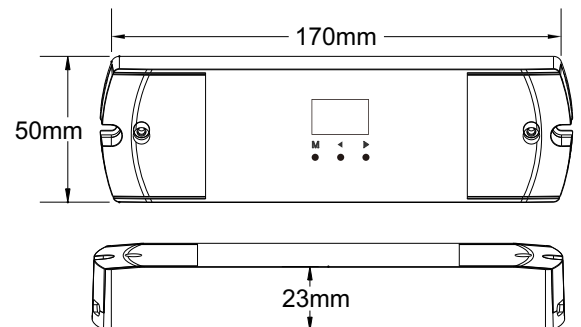
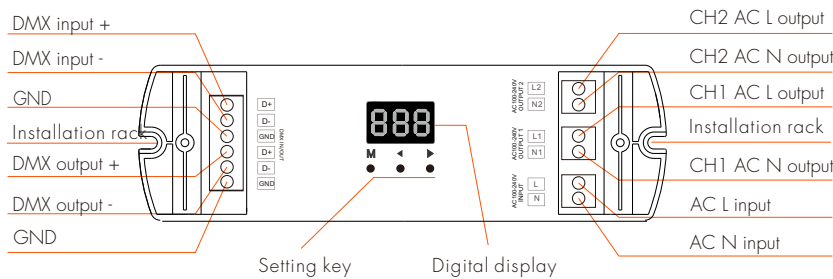

Wiring Diagram

Caution: Please carefully ensure all wire connections and polarities are correct and secure before applying power, otherwise this controller will be damaged.

- Connect with dimmable LED light

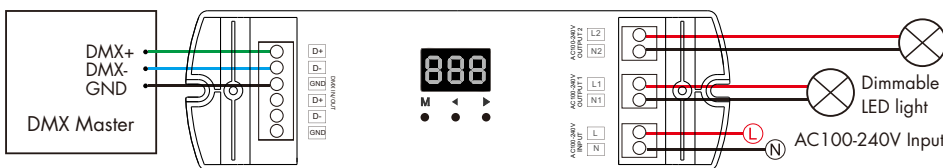

- Connect with Triac dimmable LED driver

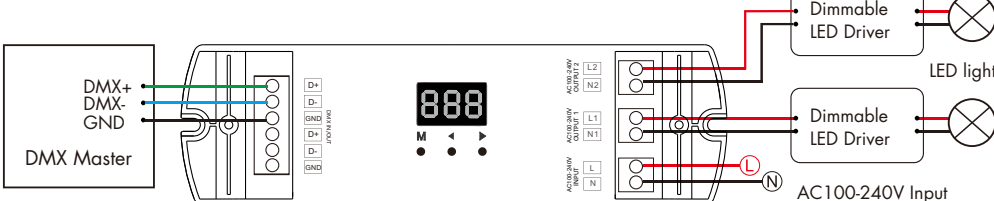

Note: When calculating the maximum number of load lamps or drivers, the input power or input current parameters of a single lamp or driver must be used, the output power parameters can not be used. In addition, the maximum surge current of the dimmer is 60A, the sum of surge current of multiple dimmable LED drivers should not exceed 2 times. otherwise, the product will be overloaded and damaged.

Operation

System parameter setting

- Long press M and ◀ key for 2s, prepare for setup system parameter: decode mode, control method, default output level, minimum brightness curve, automatic blank screen. short press M key to switch five item.
- Decode mode: short press ◀ or ▶ key to switch one-channel decode("d-1") or two-channel decode("d-2").
When set as 1 channel decode, the decoder occupy only 1 DMX address, and two channel output the same brightness of this DMX address.
- Control method: short press ◀ or ▶ key to switch forward-phase("C-F") or reverse-phase("C-R").

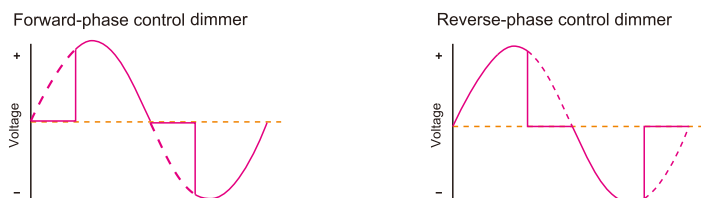

- Minimum brightness: short press ◀ or ▶ key to set minimum brightness, from 1% to 40%("b01" to "b40"). You need set suitable minimum brightness to avoid flick.
- Default output level: press ◀ or ▶ key to change default 0-100% level ("d00" to "dFF") when no DMX input signal.
- Automatic blank screen: short press ◀ or ▶ key to switch enable("bon") or disable("boF") automatic blank screen.
- Long press M key for 2s or timeout 10s, quit system parameter setting.

DMX mode

- Short press M key, when display 001~512, enter DMX mode.
- Press ◀ or ▶ key to change DMX decode start address(001~512), long press for fast adjustment.
- If there is a DMX signal input, will enter DMX mode automatically.
- DMX Dimming: Each S1-D DMX decoder occupy 2 DMX address when connecting the DMX console.
For example, the defaulted start address is 1, their corresponding relationship in the form:

DMX Console	DMX Decoder Output
CH1 0-255	CH1 0-100%
CH2 0-255	CH2 0-100%



DMX mode
(001~512)

Stand-alone dimmer mode

- Short press M key, when display L-1~L-8, enter stand-alone dimmer mode.
- Press ◀ or ▶ key to change dimmer mode number(L-1~L-8).
- Each dimmer mode can adjust each channel brightness independently.
Long press M key for 2s, prepare for setup two channel brightness.
Short press M key to switch two channel(100-1FF, 200-2FF).
Press ◀ or ▶ key to setup brightness value of each channel.
Long press M key for 2s, or timeout 10s, quit setting.
- Enter stand-alone dimmer mode only when DMX signal is disconnected or lost.



Stand-alone dimmer mode
(L-1~L-8)

Stand-alone dynamic mode

- Short press M key, when display P-1~P-4, enter stand-alone dynamic mode.
- Press ◀ or ▶ key to change dynamic mode number(P-1~P-4).
- Each mode can adjust speed and brightness.
Long press M key for 2s, prepare for setup mode speed, brightness.
Short press M key to switch two item. Press ◀ or ▶ key to setup value of each item.
Mode speed: 1-10 level speed(S-1, S-9, S-F).
Mode brightness: 1-10 level brightness(b-1, b-9, b-F).
Long press M key for 2s, or timeout 10s, quit setting.
- Enter stand-alone dynamic mode only when DMX signal is disconnected or lost.



Stand-alone dynamic mode
(P-1~P-4)



Speed
(8 level)

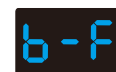

Brightness
(10 level, 100%)

Dynamic mode list

No.	Name
P-1	2ch light on/off synchronously
P-2	2ch single light on/off in sequence
P-3	2ch light fadein and fadeout synchronously
P-4	2ch light fadein and fadeout in sequence

Restore factory default parameter

- Long press ◀ and ▶ key for 2s, restore factory default parameter, display "RES".
- Factory default parameter: DMX decode mode, DMX decode start address is 1, two channel decode, reverse-phase control, 10% minimum brightness, dimmer mode number is 1, dynamic mode number is 1, output 100% level when no DMX input, disable automatic blank screen.

Compatible Load Types

Load Type	Maximum Load	Remarks
Dimmable LED lamps	100W @ 220V 50W @ 110V	Due to variety of LED lamp designs, maximum number of LED lamps is further dependent on power factor result when connected to dimmer.
Triac Dimmable LED drivers	200W @ 220V 50W @ 110V	Maximum permitted number of drivers is 100W divided by driver nameplate power rating, and make sure the surge current is no more than 2 times 60A.
Incandescent lighting, HV Halogen lamps	200W @ 220V 200W @ 110V	