



Product Specification

Title	DALI Dimmable LED Driver
Model	BQ-075DNAV (Constant Voltage / Flicker Free)
Specification	Input: 220~240Vac 50/60Hz Output: 12V/6.25A 24V/3.125A
Power Range	75W
Author	R&D
Document NO.	RDPS-2602
Date	2022-09-11
Revision	2.0

1. Product Description

1.1 This engineering report describes the design for a **DALI dimmable Constant Voltage LED Driver** for LED applications.

1.2 Prototype Photo

1.3 Physical size

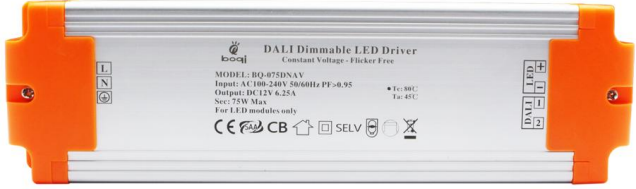
	L	W	H
	(mm)	(mm)	(mm)
	205 ±1	59 ±1	33 ±1

Features

- 220~240Vac 50/60Hz
- Built-in active PFC function
- Flicker Free
- Short circuit, Over current, Over voltage Protection
- Air Cooling
- Integrated Dali standard interface
- Applied to LED lighting etc
- No load and Safety Protection Device
- Installed economically and quickly
- Complied with the world safety standard of lighting
- protection class II
- 5 years Warranty

Description

BQ-075DNAV DALI dimmable LED Driver is a kind of Constant Voltage dimmable LED power supply that our company R&D, with high power factor, high efficiency, high precision, adopting the high efficiency, stable, low loss of switch control chip. It was made with high-quality components, so it had the characteristics like low noise, energy-saving, environmental protection, and long life, etc.

1.4 / Working principle

BQ-075DNAV DALI Dimmable LED Driver is with the Constant Voltage

feature, the working condition is as the picture under.

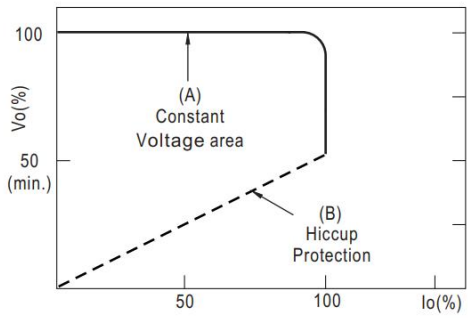

Typical output current normalized by rated current (%)

2. Electric Idiosyncrasy

2.1 Specs.

Model		BQ-075DNAV	
Output	DC Voltage	12V	24V
	Output Current	6.25A	3.125A
	Output Power	75W	
	Flicker Index	Modulation depth ≤1% Complies with the flicker-free standard (IEEE Std 1789-2015)	
	Voltage Tolerance	±0.5V	
	Line Regulation	±0.5%	
	Load Regulation	±2.0%	±0.5%
Input	Voltage Range	220-240VAC	
	Frequency Range	47-63Hz	
	*Power Factor(Typ.)@ full load	0.95@230VAC	
	THD(Typ.)@ full load	<20%	
	Efficiency(Typ.)@ full load	90%	91%
	AC Current(Max.)	0.43A@230VAC	
	Inrush Current (Typ.)	20A, 50%, 1.6ms	
	Leakage current	<0.50mA	
Protection	Short Circuit	shut down o/p voltage, re-power on to recover after fault condition is removed	
	Over Loading	≤120% constant current limiting, auto-recovery	
	Over temperature	100°C±10°C shut down o/p voltage, automatically recover after cooling.	
Environment	Working TEMP.	-40~+60°C (see below derating curve)	
	Working Humidity	20~90%RH, non-condensing	
	Storage TEMP. Humidity	-40~+80°C, 10~95%RH	
	TEMP .coefficient	±0.03%/°C (0~60°C)	
	Vibration	10~500Hz, 2G 10min./1 cycle,period for 60min. each along X,Y,Z axes	
Safety& EMC	Safety standards	EN61347	
	Withstand voltage	I/P-O/P: 3.75KVac	
	Isolation resistance	I/P-O/P: 100MΩ/500VDC/25°C/70%RH	
	EMC EMISSION	EN55015; EN61000-3-2; EN61000-3-3;	
	EMC IMMUNITY	EN61547	
Others	Net. Weight	0.4KG	
	Dimension	205*59*33mm (L*W*H)	
	Warranty	5 Years	

2.2 Characteristic Curve

2.2.1 Power Factor Characteristic Curve

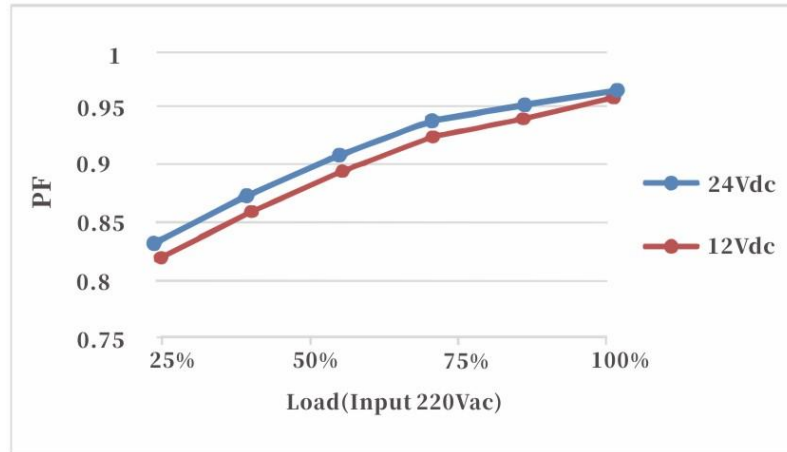

2.2.2 Power Efficiency Characteristic Curve

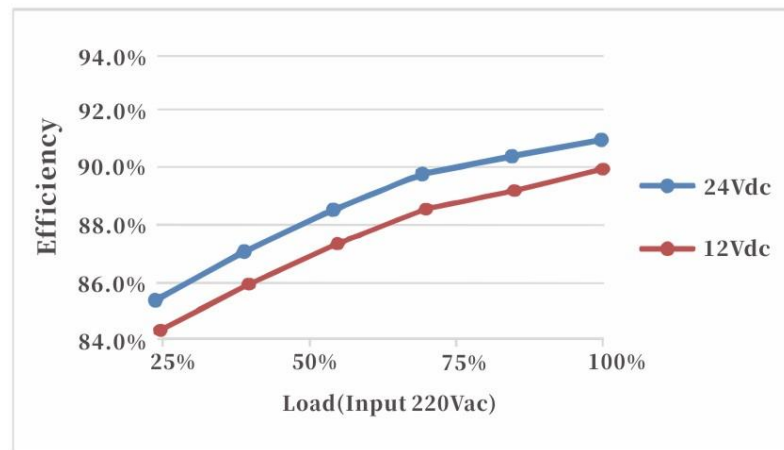

2.2.3 Lifetime Characteristic Curve

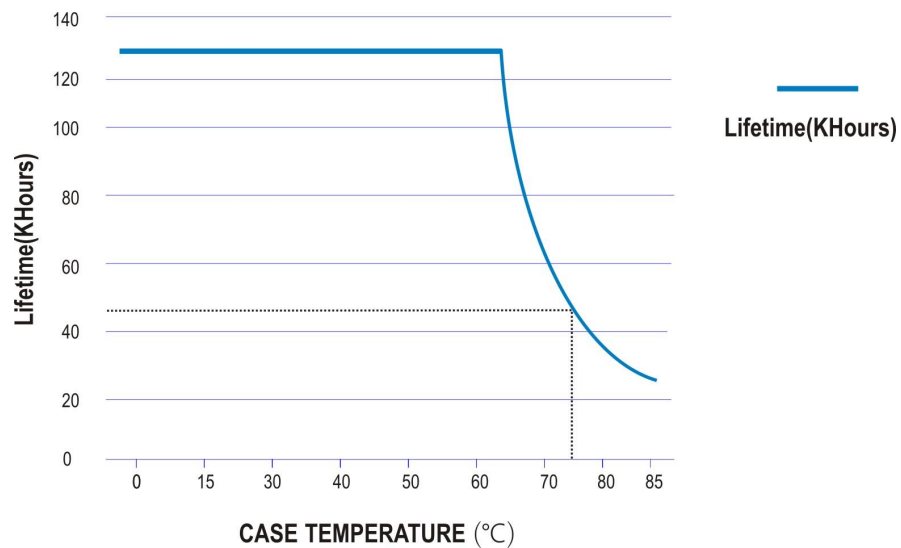

2.2.4 Dimming Curve

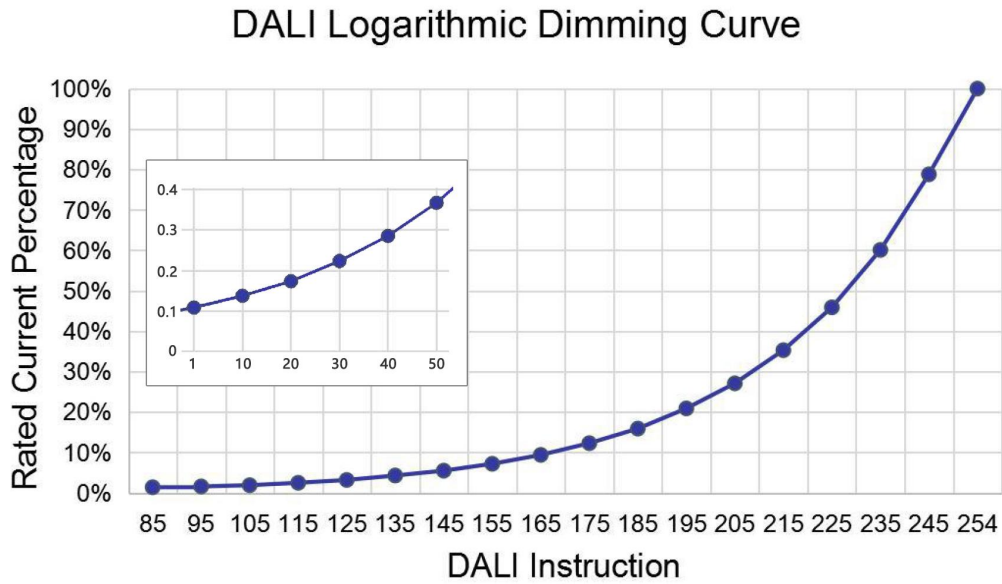

Operation Instructions of DALI Dimming

Factory default setting is of 100% brightness.

Connect the DALI signal to the DA1 and DA2 terminals.

DALI protocol includes 16 groups and 64 IP addresses.

The minimum dimming depth of the DALI dimming is 0.1% (Iout).

2.3 Circuit Drawing

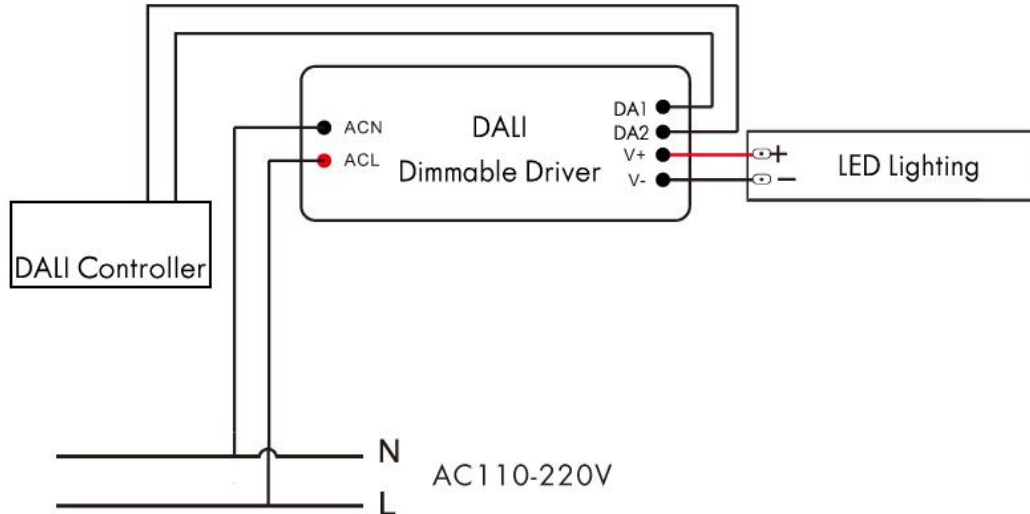

1. When using this product, Please differentiate its input and output terminal. PRI is AC input, Connect ACL to firing line, ACN to null line; DC output, LED + and LED - connect the positive and negative of LED lamps separately; DA1 and DA2 DALI signal lines, no need to differentiate the positive and negative.

2. This product is a high Voltage LED lamps controller, please cut off the power before installation, Wiring according to the chart as shown, Connect LED+ and LED- , then connect the DA1 and DA2 signal wire, at last connect ACL and ACN. After verification to electricity.

3. Real Photo

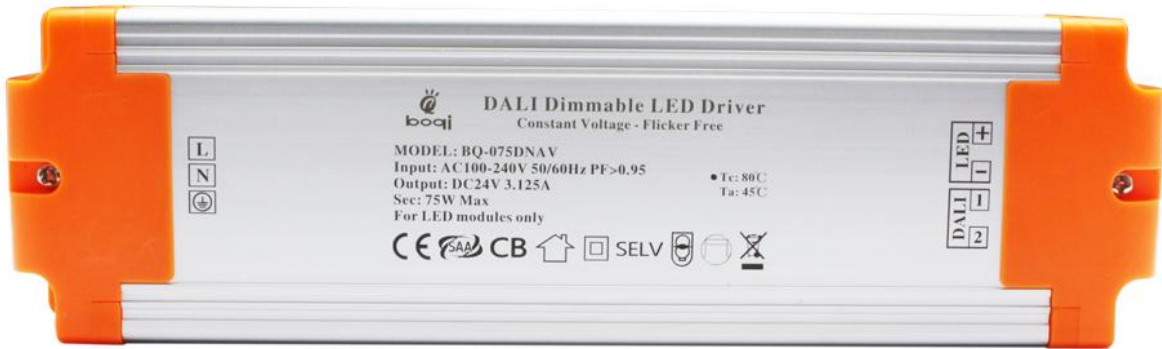
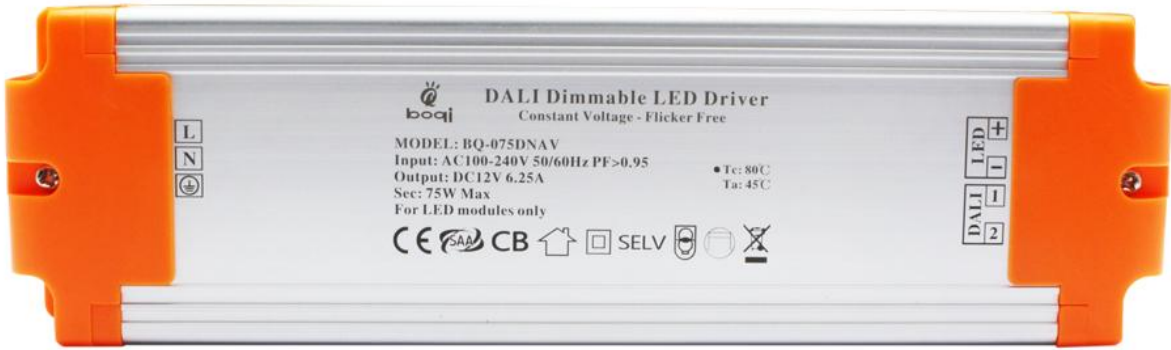



The product is installed according to the chart as shown, If meet the below faults :

1. LED lamp is not bright,Please cut off the power, and check
 - a. Whether the output end is bad contact.
 - b. Whether the positive negative of the output end are against.
 - c. Whether the input end is bad contact.
 - d. Whether the LED line and DALI signal line are against. Test again after

excluding below fault.

2. Light-up the LED lamp, but the brightness is abnormal (LED lamp is flicking, too bright or too dark) or can not be dimmed, Please cut off the power immediately, and check if the LED lamps accord with the products' output demand(LED lamp power is too small or too big), whether the DALI parameters are set correctly.

3. During the product using, If you meet other queries,and can not solve by yourself, Please contact us immediately. We will try our best to improve and optimize in time.