



Product Specification

Title	DALI Dimmable LED Driver
Model	BQ-030DNPC
Specification	Input: 100~265Vac 50/60Hz Output: 36-60V/400mA 24-42/600mA
Power Range	15-24W
Author	R&D
Document NO.	RDPS-2304
Date	2021-01-04
Revision	2.0

1. Product Description

1.1 This engineering report describes the design for a **DALI dimmable Constant Current led driver** for LED applications.

1.2 Prototype Photo

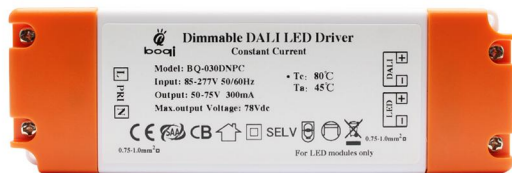

1.3 Physical size

	L (mm)	W (mm)	H (mm)
	130	43	21
	±1	±1	±1

Features

- 100~265Vac 50/60Hz
- Built-in active PFC function
- Short circuit,Over current,Over voltage Protection
- Air Cooling
- Integrated Dali standard interface

- Applied to LED homing and commercial lighting etc
- No load and Safety Protection Device
- Installed economically and quickly
- Complied with the world safety standard of lighting
- Protection class II
- 5 years Warranty

Description

BQ-030DNPC DALI dimmable LED Driver is the kind of CC dimmable LED power supply that our company R&D, with high power factor, high efficiency, high precision, adopting the high efficiency, stable, low loss of switch control chip. It was made with the high quality components, so it had the characteristics like low noise, energy saving, environmental protection and long life etc.

1.4 Working principle

BQ-030DNPC DALI Dimmable LED Driver is with the CC feature, the working condition is as the picture under.

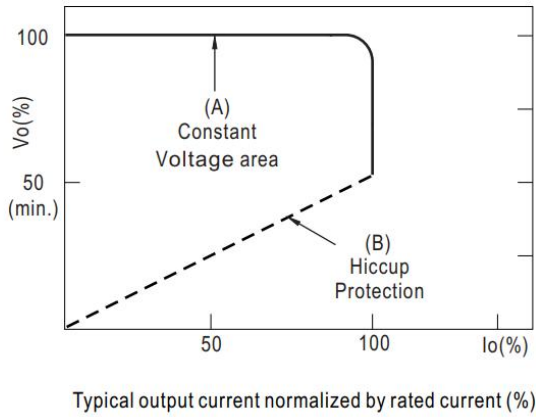

2. Electric Idiosyncrasy

2.1 Specs.



Model	BQ-030DNPC		
Output	DC Voltage	36-60V	24-42V
	Output Current	400mA	600mA
	Output Power	15-24W	
	Flicker Index	Modulation depth ≤1% Complies with the flicker-free standard (IEEE Std 1789-2015)	
	Ripple Current	<5%(rated current)	
	Current Tolerance	±5%	±5%
	Temperature Drift	±5%	
	Start-up Time	<1.5S@230Vac	
Input	Input Voltage	100-265VAC	
	Frequency Range	47-63Hz	
	Power Factor(Typ.)	0.97@115VAC 0.95@230VAC @ full load	
	THD(Typ.)@ full load	<20%@230Vac (DC42V full load)	
	Efficiency(Typ.)	88%@ full load	88%@ full load
	AC Current(Max.)	0.3A	
	Inrush Current (Typ.)	≤20A&120uS@230Vac (Max)	
	Leakage current	<0.7mA	
	Standby Power Consumption	≤0.5W (when DALI OFF signal is effective)	
Protection	Short Circuit	Hiccup mode (auto-recovery)	
	Over temperature	100℃±10℃ shut down o/p voltage, automatically recover after cooling.	
Environment	Working TEMP.	-20℃ - +45℃ (see below derating curve)	
	Working Humidity	20~90%RH, non-condensing	
	Storage TEMP.Humidity	-30~+80℃, 10~90%RH	
	Atmospheric Pressure	86kPa~106kPa	
Safety& EMC	Certifications	TUV-CE, CB, SAA, RoHS	
	Safety standards	EN61347	
	Withstand voltage	I/P-O/P: 3.75KVac 5mA 60S	
	Insulation Resistance	I/P-O/P:100MQ/500VDC/25℃/70%RH	
	EMC EMISSION	EN55015; EN61000-3-2; EN61000-3-3;	
EMC IMMUNITY	EN61547		
Others	DALI Standard	IEC 62386-101 102 207: DALI 2.0	
	Dimension	130*43*21 mm (L*W*H)	
	Warranty	5 Years (Tc≤77.5℃)	

2.2 Characteristic Curve

2.2.1 Power Factor Characteristic Curve

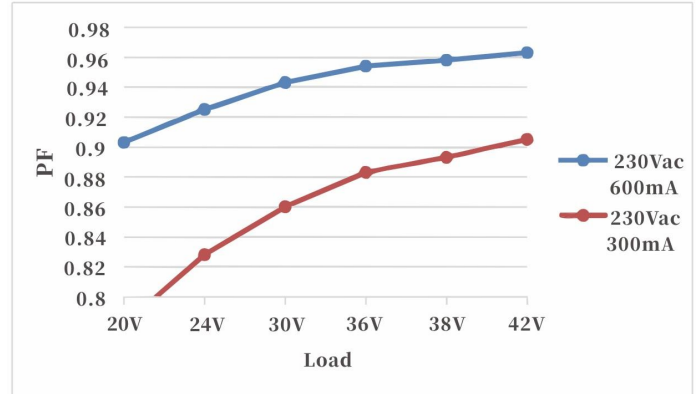
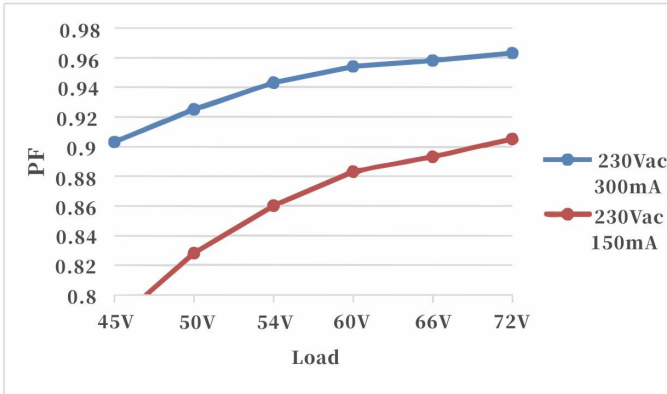

2.2.2 Power Efficiency Characteristic Curve

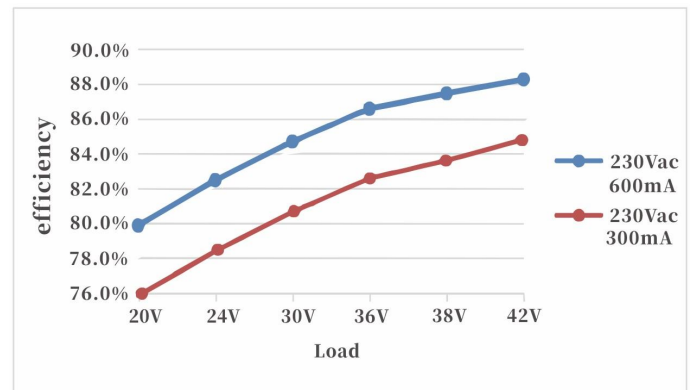
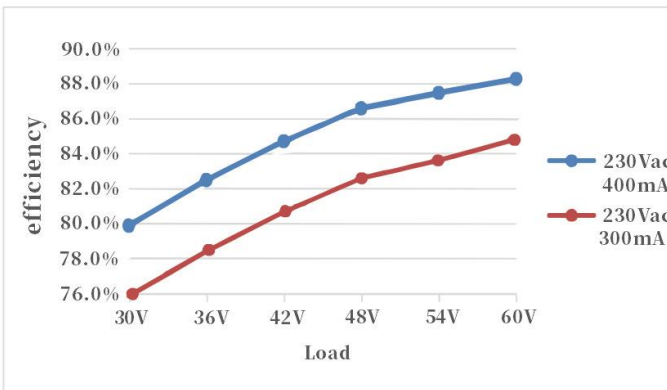

2.2.3 Lifetime Characteristic Curve

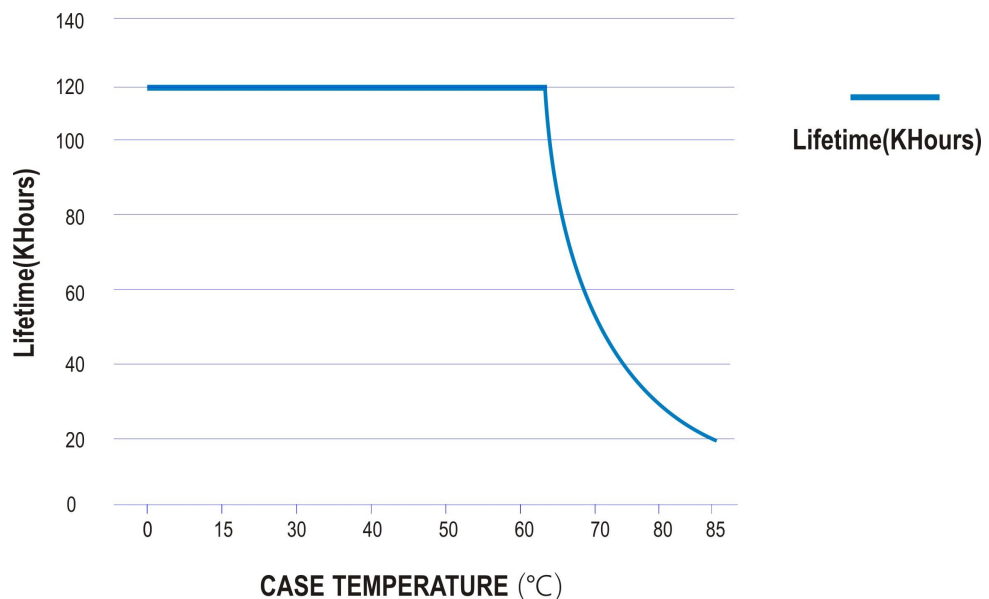

2.2.4 Dimming Curve

DALI Logarithmic Dimming Curve

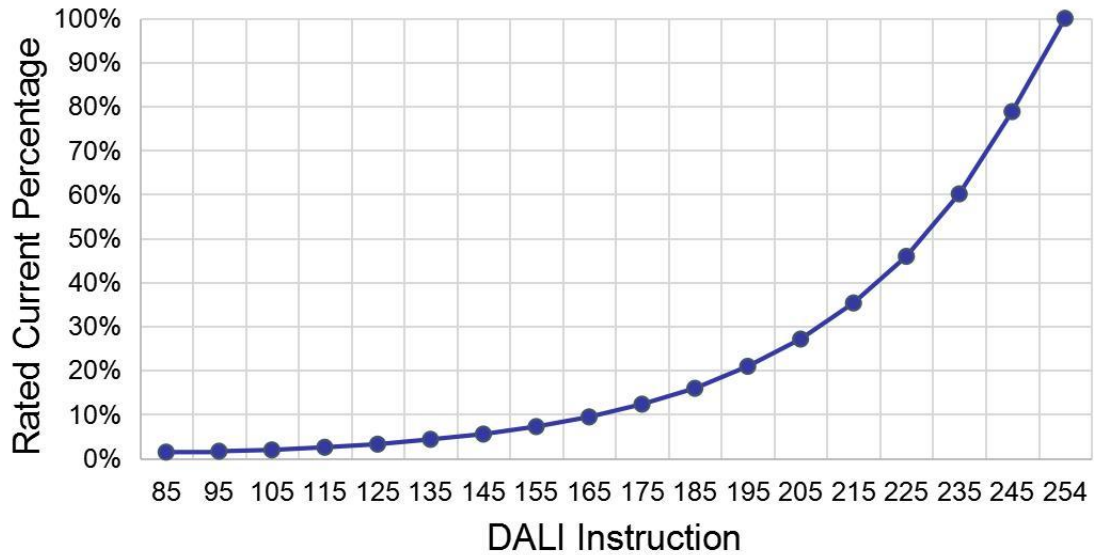

Operation Instructions of DALI Dimming

Factory default setting is of 100% brightness.

Connect the DALI signal to the DA1 and DA2 terminals.

DALI protocol includes 16 groups and 64 IP addresses.

The minimum dimming depth of the DALI dimming is 0.1% (Iout).

2.3 Circuit Drawing

1. When using this product, Please differentiate its input and output terminal. PRI is AC input, Connect ACL to firing line, ACN to null line; DC output, LED + and LED - connect the positive and negative of LED lamps separately; DA1 and DA2 DALI signal lines, no need to differentiate the positive and negative.

2. This product is a high Voltage LED lamps controller, please cut off the power before installation, Wiring according to the chart as shown, Connect LED+ and LED- , then connect the DA1 and DA2 signal wire, at last connect ACL and ACN. After verification to electricity.

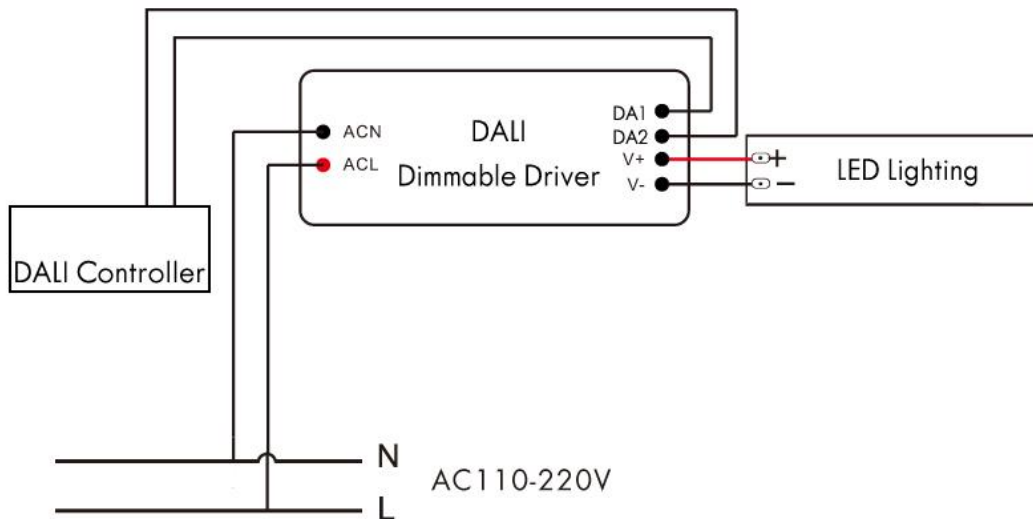

3. Real Photo

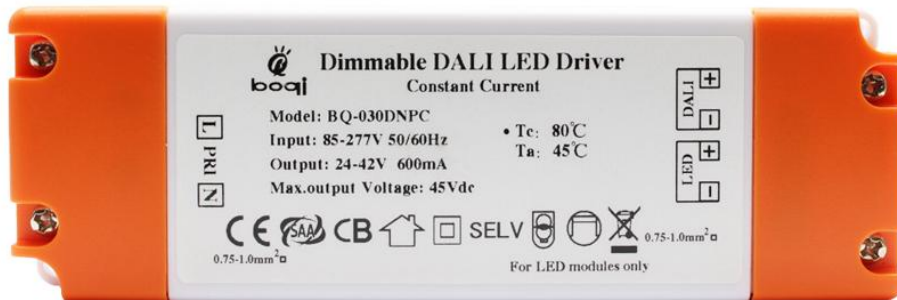
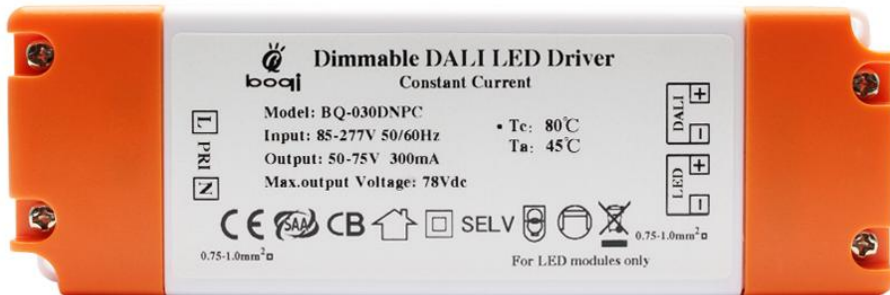

Common Fault and Handing Method

The product is installed according to the chart as shown, If meet the below faults :

1. LED lamp is not bright,Please cut off the power, and check
 - a. Whether the output end is bad contact.
 - b. Whether the positive negative of the output end are against.
 - c. Whether the input end is bad contact.
 - d. Whether the LED line and DALI signal line are against. Test again after

excluding below fault.

2. Light-up the LED lamp, but the brightness is abnormal (LED lamp is flicking, too bright or too dark) or can not be dimmed, Please cut off the power immediately, and check if the LED lamps accord with the products' output demand(LED lamp power is too small or too big), whether the DALI parameters are set correctly.

3. During the product using, If you meet other queries,and can not solve by yourself, Please contact us immediately. We will try our best to improve and optimize in time.